

CENS.com Digital Magazines

Jul. 15, 2017 Volume 07

Hardware



New Era for Hardware

**Hardware Products from
Taiwan, Designed to
Reshape the Way People
Work and Live**



Guide to E-magazine

Content Sections

CENS.com

Access to CENS.com for more information, industry news & reports.



Online Product Index

Find quickly product categories of interest.



Advertiser Index

Find easily suppliers of interest.



Articles

Find here industry news, reports, and editorial articles.



For details on suppliers & products

Simply use hyperlink icons:

Inquire Now

Click **Inquire Now** to safely, quickly connect to online inquiry form for the advertiser/supplier.

Webpage

Click **Webpage** to connect to the introduction of the advertiser/supplier.



Guide to E-magazine

Content Sections

CENS.com

Access to CENS.com for more information, industry news & reports.



Online Product Index

Find quickly product categories of interest.



Advertiser Index

Find easily suppliers of interest.



Articles

Find here industry news, reports, and editorial articles.



For details on suppliers & products

Simply use hyperlink icons:

Inquire Now

Click **Inquire Now** to safely, quickly connect to online inquiry form for the advertiser/supplier.

Webpage

Click **Webpage** to connect to the introduction of the advertiser/supplier.



Index

A-BELT-LIN INDUSTRIAL CO., LTD.	27
ABA UFO INTERNATIONAL CORP.	33
ACCLAIM & LEE ASSOCIATES, INC.	29
CLEAR DAWN CO., LTD.	25
DEFA INTERNATIONAL INC.	40
ELEM TECHNOLOGY CO., LTD.	24
FONG PERNG INTERNATIONAL CORP.	31
GEORGE WANG INDUSTRIAL CO., LTD.	11
HOU LIH CO., LTD.	34
JIH SHENG SPRING CO., LTD.	35
KAE DIH ENTERPRISE CO., LTD.	16
KINGBOLT METAL CO., LTD.	32
LEADING TOOLS INDUSTRIAL CO., LTD.	36
NAN SHUN SPRING CO., LTD.	39
NINGBO MAMMOTH HARDWARE PRODUCTS CO., LTD.	20
SANE JEN INDUSTRIAL CO., LTD.	21
SUNG CHIEH INDUSTRY CO., LTD.	22
TAIWAN MAGNETIC CORP. LTD.	37
TSAI HSING FA CO., LTD.	18
WILLIAM TOOLS CO., LTD.	12
YOUNG LEE STEEL STRAPPING CO., LTD.	14

Contents

■ Tools (Hand Tools And Hardware)	10
■ Tools (Electric-Powered Tools And Hardware)	15
■ Tools (Auto Tools & Equipment)	17
■ Gardening Tools & Accessories	19
■ Industrial Hardware, Mechanical Hardware, Vehicular Hardware, And Tool-Related Products	23
■ Watercraft Safety Equipment (Deck Hardware, Towing Equipment, Winches, Jacks, Etc.)	26
■ Bathroom Fittings (Including Washbasins, Bathtubs, Mirrors, And Toilets)	28
■ Furniture And Building Hardware (Locks Included)	30
■ Screws & Bolts	38



Guidebook to CENS Hardware

2016-04 Edition

Global buyers looking for quality hardware including hand tools, screws, locks, plumbing fixtures, building materials, furniture hardware and even niche products from Taiwan must read CENS Hardware, another informative buyer guide that puts Taiwan's hardware suppliers at your fingertips. 1 Issue per year (April)

Index of Selected Suppliers

- Special Pages
- Hand Tools, Pneumatic Tools, Electric-Powered Tools, And Hardware Accessories
- Boat Wrecking & Building Tools & Equipment
- Watercraft Safety Equipment (Deck Hardware, Towing Equipment, Winches, Jacks, Etc.)
- Watercraft Plumbing & Hardware
- Tools (Hand Tools and Hardware)
- Tools (Pneumatic Tools and Hardware)
- Tools (Electric-Powered Tools and Hardware)
- Tools (Auto Tools & Equipment)
- Gardening Tools & Accessories
- Industrial Hardware, Mechanical Hardware, and Other Tool-Related Products
- Branded Tools & Equipment, and Other Tool-Related Products (Including Subcontracting and Processing)
- Bathroom Fittings (Including Washbasins, Bathtubs, Mirrors, and Toilets)
- Furniture and Building Hardware (Locks Included)
- Household Hardware (For Household Products and Small Electrical Home Appliances)
- Other Building-Material-Related Products (Including Subcontracting and Processing Services)
- Screws & Bolts
- Rivets, Rubber Washers, Pins & Anchor Screws
- Rod and Wire-Type Items
- Molds/Dies, Screw-Making Machinery and Peripheral Equipment
- Safety & Security Equipment



ALUMINIUM China 2016 drew over 19,500 visitors during its three-day run (photo courtesy of the organizer).

ALUMINIUM China 2016 Rounded Off With Promising Turnout

Trade fair drew over 19,500 visitors worldwide to consolidate reputation as China's largest for aluminum industry

By Steve Chuang

The largest trade fair for the aluminum-related industries in China by size, ALUMINIUM China brings together industry insiders and experts, state-of-the-art technologies and advanced applications every year to have served as a leading business platform of this kind in Asia.

In the 2016 edition, the trade fair attracted some 19,530 visitors and delegates from 75 countries and regions worldwide during its 3-day run, with more than 400 exhibitors present.

The quality of visitors remained great. Around

one third of the visitors in the 2016 edition were automotive manufacturers and one tenth from packaging and transport sectors. The show organizer, Reed Exhibitions, reports that more than 80% of the visitors play an important role in purchasing decisions.

ALUMINIUM China 2017 will take place from July 19 to 21 at Shanghai New Intl Expo Centre.

ALUMINIUM China 2017 will focus on the automotive light-weighting applications in particular, to help keep participants dated with various multi-material, multi-process and multi-technology solutions.

To better enhance exchanges between suppliers and buyers, the show will offer factory visits for international visitors to collect first-hand information on potential China suppliers as well as host a series of conferences and seminars that cater to

producers seeking breakthroughs in product range as well as technical advancements.

Further information on www.aluminiumchina.com/en/. [CENS](#)

Post-show Report

ALUMINIUM CHINA 2016

A professional sourcing and networking platform for China's complete aluminium industry chain

400* Exhibitors **35,000*** m² Exhibition Area **19,530*** Trade visitors & delegates

Comprehensive Coverage of the Asia Market

The event lasted three days and attracted 19,530 visitors and buyers from 75 countries and regions worldwide.

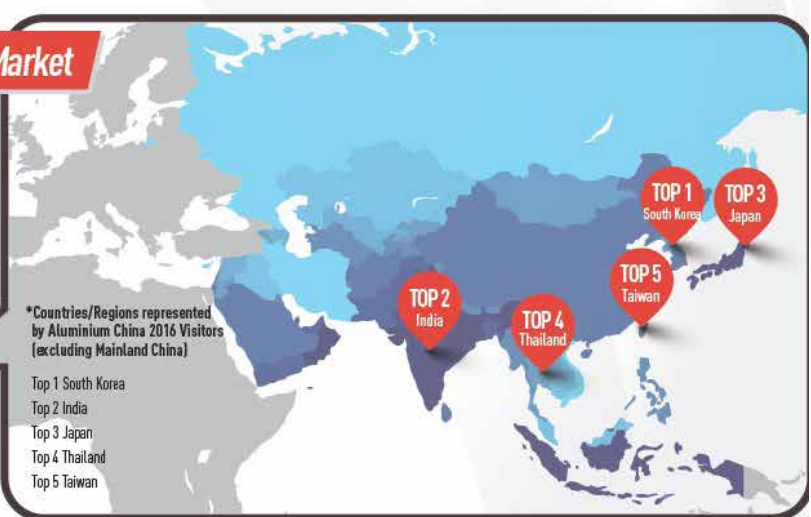
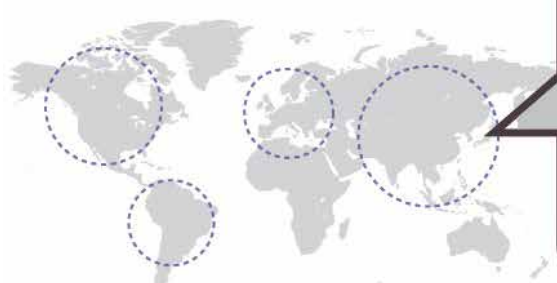

Proportion of Visitors from End User Companies Rises Year after Year

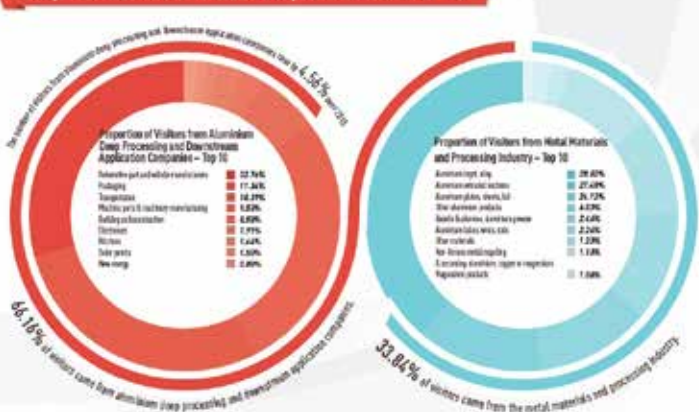

Domestic Visitors' Role in Making Purchasing Decisions

84% of domestic visitors play a role in purchasing decisions. 27% of them are the final decision-maker.

Decision Maker: 27%
 Recommender: 40%
 Specifier: 17%
 Not involved in purchasing process: 16%

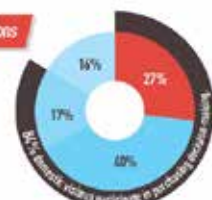

Overseas Visitors' Role in Making Purchasing Decisions

88% of overseas visitors play a role in purchasing decisions. 54% of them are the final decision-maker.

Decision Maker: 54%
 Recommender: 24%
 Specifier: 8%
 Not involved in purchasing process: 14%

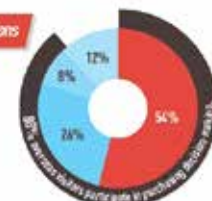



Like our Facebook fan page

CENS – Taiwan Sourcing Service Provider

for the latest updates about
suppliers, products, industry news,
and **trade shows**

Like **CENS**

-&-

Enjoy CENS Sourcing Service!



Tools (Hand Tools And Hardware)

GEORGE WANG INDUSTRIAL CO., LTD.	11
WILLIAM TOOLS CO., LTD.	12
YOUNG LEE STEEL STRAPPING CO., LTD.	14



Side Cutter Pliers

GEORGE WANG INDUSTRIAL CO., LTD.

Tel:886-4-779-4228
Fax:886-4-779-4249
E-mail: george.aska@msa.hinet.net
Website: www.georgewang.com.tw

Established in 1994.GEORGE WANG INDUSTRIAL CO.,LTD.Is a professional manufacturer of stainless steel pliers. We are making a variety of pliers which suitable for making jewelry, handicraft, fishing, bead and small precision equipment...ect. We have the best experience in this field for years So that we are fully confident to offer the best product to our customers with low price and fast ...



Hooked Nose Pliers



Long Nose Pliers



Chain Nose Pliers

WILLIAM TOOLS CO., LTD.



Ratchet Handles



Ratchet Handles



Ratchet Handle



Round Head Ratchet Insert

The Leading Ratchet Wrench Manufacturer Being familiar with the manufacturing process of hand tools, William Tools. Co., Ltd. has become one of the leading companies of Ratchet Handle in Taiwan and worldwide for over two decades. Mr. William Chiang, the founder of William Tools, has also engaged in hand tools manufacturing for the past 25 years, and all products we made come from his hands. Presently, we've already established our Research & Development Dept. to offer the best service to our customers, and we've also cooperated with the well-known



WILLIAM TOOLS CO., LTD.

No. 8, Keya Rd., Central Taiwan Science Park,
Taya Dist., Taichung City, Taiwan 428

Tel:886-4-2565-8358

Fax:886-4-2565-8359

E-mail: willtool@ms34.hinet.net

Website: www.cens.com/william

Torque Wrenches, Ratchet Handle, Ratchet Box Wrenches, Boat-repair Tools, Mini Round Head Ratchet Handle, Ratchet



Screen Torque Wrenches



Screen Torque Wrenches



Ratchet Handle



Ratchet Handle

YOUNG LEE STEEL STRAPPING CO., LTD.

**Steel Strapping, Strapping Tools,
Steel Pipes, Steel Furniture, Metal-
Tube Furniture, K/D furniture,
Seal, Strapping Cars**

Founded in 1976, Young Lee Steel Strapping Co., Ltd. sold soft packing materials and packing machinery in its initial stage, and started to provide steel strapping bands, steel buckles, steel furniture tubes, cold/hot-rolled steel (plates) rolls, and galvanized steel (plates) rolls in 1980. In 1998, we established a factory making steel straps—steel strapping bands and steel furniture tubes—steel pipe which also works with downstream manufacturers to provide bathroom and furniture hardware, grills, and display racks, among other items. We are also an asia agent for steel strapping tools of COLUMBIA, M.J. MAILLIS GROUP. We welcome players in the industry to cooperate with us in developing new products and to act as our agents overseas. We can also provide procurement services by purchasing whatever you need from the domestic and China ...



**YOUNG LEE STEEL STRAPPING CO.,
LTD.**

No. 65, Lane 540, Yungfang Rd., Tungfang Borough,
Changhua, Taiwan 500

Tel: 886-4-763-8998

Fax: 886-4-763-8991

E-mail: yly.j66@msa.hinet.net

Website: www.asiastrapping.com



Steel strapping, steel strap, steel banding,
baling hoop, steel tape, steel strip



19mm Extra-long Steel Seal for
Pneumatic Strapping (Push-on seals)

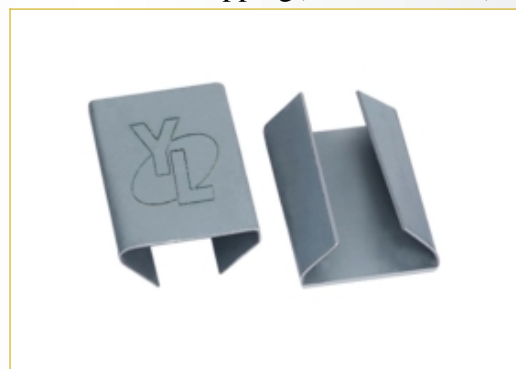

25mm C-type Steel Seals for Manual
Strapping (Snap-on seals)



32mm C-type Steel Seals for Pneumatic
Strapping



Tools (Electric-Powered Tools And Hardware)

KAE DIH ENTERPRISE CO., LTD.

16

KAE DIH ENTERPRISE CO., LTD.

Industrial Vacuum Cleaners, Wet & Dry Vacuum Cleaners, Electric Random Orbital Sander, Spray Paint Collectors, Vacuum Cleaners

KaeDih Enterprise Co., Ltd. established in 1983, has been devoted to industrial vacuums right from the beginning. We are pioneers in the manufacturing of industrial cleaners and have taken our brand name as "JESON." We've researched and developed a wide variety of professional vacuum cleaners to fit our broad spectrum of clients in all fields. In addition to general vacuum cleaners, we also create customized cleaners for each of our customer's unique needs in order to satisfy any demand and meet all ecological requirements KAE-DIH upholds the spirit of pursuing excellence and innovation. We seek breakthrough techniques to produce better products and actively expand the development of related manufacturing methods and products. We've cultivated our own manufacturing technique to stay ahead of the competition by continually researching and



KAE DIH ENTERPRISE CO., LTD.

No. 357, Sec.1, ChengGong Rd., Puyen Twonship, Changhua County, Taiwan 516

Tel:886-4-865-5545

Fax:886-4-865-5471

E-mail: sales@kaedih.com.tw

Website: www.cens.com/kaedih



Professional Vacuum Cleaners



Professional Vacuum Cleaners



Professional Vacuum Cleaners



ELECTRIC RANDOM ORBITAL SANDERS



Tools (Auto Tools & Equipment)

TSAI HSING FA CO., LTD.

18



SEARCH

[THE TOOLS]

YOU WANT



TSAI HSING FA CO., LTD.
www.skautoservice.com.tw
tsaifa@ms34.hinet.net
+886-4-2436-8238



Gardening Tools & Accessories

NINGBO MAMMOTH HARDWARE PRODUCTS CO., LTD.	20
SANE JEN INDUSTRIAL CO., LTD.	21
SUNG CHIEH INDUSTRY CO., LTD.	22

NINGBO MAMMOTH HARDWARE PRODUCTS CO.,

**Sprinklers, Nozzles, Water Wand,
Oscillating, Lawn & Garden
Products, Hose Nozzles, Hose
Connectors, Hose Hangers**

We are a professional lawn & garden sprinkler manufacturer in Taiwan and China. Our product range includes hose nozzles, stationary sprinklers, impulse sprinklers, hose connectors and more which have been marketed in the U.S., Canada, Australia and many other countries. And all of our products are available in various specifications meet customer's requirements. With an outstanding R&D team and complete production equipment, we can handle from design and mold development to injection sprinklers through an integrated operation, making us your best choice for OEM cooperation. Don't wait and come to MAMMOTH today for sprinklers with the best quality at the competitive prices!

NINGBO MAMMOTH HARDWARE PRODUCTS CO., LTD.

Zhangting Industrial Area, Yuayo, Zhejiang Province, China

Tel: 86-574-6298-8850/5

Fax: 86-574-6298-8858

E-mail: m9999.m597@msa.hinet.net

Website: www.cens.com/ningbo



Hose Carrier



Hose Carrier



Accessories



Water Wand



User instructions for foldable wire containers

SANE JEN INDUSTRIAL CO., LTD.

Tel:886-5-213-4789
Fax:886-5-213-4699
E-mail: sj-storage@umail.hinet.net
Website: www.sj-storage.com.tw

Sane Jen Industrial Co., Ltd., was founded in 1984. It was specialized in developing and manufacturing folding wire containers, trolley, folding storage shelves, stacking frames, metal pallet, wire display shelves, wire decking, wire basket, wire netting... etc. for Logistics, Warehouse Storage and Supermarkets. The products made of iron wire, steel tubes, steel plate and stainless steel are also available. ...



A-3



A-5



A-7

SUNG CHIEH INDUSTRY CO., LTD.

Shovel, Flower scissors, Grass Scissor, Tree Shear, Telescopic Rake, Rake, Multi-Change System Garden Tools, Professional House and Garden Tool

SUNG CHIEH INDUSTRY CO., LTD. is dedicated in Shovel, Flower scissors, Grass Scissor, Tree Shear, Telescopic Rake, Rake, Multi-Change System Garden Tools, Professional House and Garden Tool Supplier with operations in Taiwan

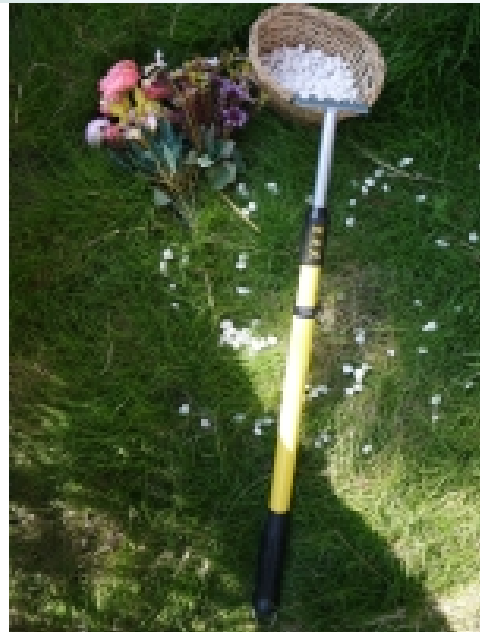

Telescopic 5T Rake



Multi-change Garden Tools



Flower scissors and Grass Scissors



Shovel

SUNG CHIEH INDUSTRY CO., LTD.

No. 62, Lane 187, Fucheng Rd., Erhkang Village, Fuhsing Township, Changhua County, Taiwan 506

Tel: 886-4-780-2288

Fax: 886-4-770-9752

E-mail: sung.jay@msa.hinet.net

Website: m.cens.com/s/84425348



Industrial Hardware, Mechanical Hardware, Vehicular Hardware, And Tool-Related Products

ELEM TECHNOLOGY CO., LTD.

24

CLEAR DAWN CO., LTD.

25



Electronic parts processing

ELEM TECHNOLOGY CO., LTD.

Tel:886-4-732-4859, 737-3069
Fax:886-4-737-3611
E-mail: elem.tw@msa.hinet.net
Website: www.cens.com/elem

Founded in 1988 in central Taiwan's Changhua City, Elem is a CNC machining factory handling optical, healthcare instrument, auto, motorcycle, sniperscope, lens, and microscope parts. Equipped with precision machining centers, CNC lathes, milling machines, grinding machines, and various testing instruments, we also process, manufacture, and assemble precision electronic, optical, mechanical, and hardware c ...



OEM ODM for Electronic parts



Electronic boxes (OEM)



Electronic parts & accessories

CLEAR DAWN CO., LTD.

Ferrule Parts, Ships, Industrial Machines, Motor Vehicles, Kitchen Machines, Kitchen Devices, Food Machines

Clear Dawn Co., Ltd was established in 1982, and the head office is located in the flourishing Xinyi Commercial District, in close proximity to Taipei's 101 building. For many years, Clear Dawn, also known as CDC, has held with management philosophy of innovation, cooperation, service and the enterprising spirit of customer focus to earn the applause and support from the customers locally and globally. The main products of CDC are Aluminum Alloy Parts, Stainless Steel Casting Parts, Titanium Fasteners, Power box, Gears, Spindles, Sleeves, Pistons and cylinders. CDC's scope of the products includes building hardware, rail construction hardware, industrial parts, CNC precise components, and the specialized components for transportation equipments, as well as supplying materials for overseas infrastructure works. CDC has been pos ...



CLEAR DAWN CO., LTD.

17th Fl.-3, No. 508, Chunghsiao E. Rd., Sec. 5, Taipei, Taiwan 110

Tel:886-2-2727-9416

Fax:886-2-2727-9415

E-mail: cdcmetal@cleardawn.com.tw

Website: www.cens.com/cleardawn



Die-casting



Metal Parts



SS Tube



Die-casting



Watercraft Safety Equipment (Deck Hardware, Towing Equipment, Winches, Jacks, Etc.)



Seat Belt, Safety Belt, Auto Parts, Auto Accessories

A-BELT-LIN INDUSTRIAL CO., LTD.

Tel:886-4-768-3100
 Fax:886-4-768-3940
 E-mail: abeltc@ms32.hinet.net
 Website: www.cens.com/abeltc

A-BELT-LIN has experiences for manufacturing seat belt, racing belt, tow rope, tie down, industrial safety belt, lift sling ,various hardware and plastics productions for over twenty years. We also applied for many kind of certifications, which including FMVSS209/302,E Mark, CE, CNS.... etc. Our customers are all around the world. For supplying our customers in diversified requirements. We has e ...



Seat Belt, Safety Belt, Auto Parts, Auto Accessories



Seat Belt, Safety Belt, Auto Parts, Auto Accessories



Seat Belt, Safety Belt, Auto Parts, Auto Accessories



Bathroom Fittings (Including Washbasins, Bathtubs, Mirrors, And Toilets)

ACCLAIM & LEE ASSOCIATES, INC.

Bathroom Accessories, Bathroom Hardware, Washbasins, Storage Racks, Tower Racks, Soap Holders, Tissue Holders, Garbage Cans

Founded in 1979 in Taipei County, Taiwan, Acclaim & Lee Associates, Inc. specializes in manufacturing and exporting bathroom fittings and accessories according to OEM/ODM/custom orders. Offering excellent quality, competitive pricing and on-time delivery, we fully meet demand to have built a good reputation. Contact a truly professional, reliable supplier of bathroom accessories.



Towel holder 29804B



Glass shelf 29809



Double towel rail 29814



Towel shelf 29833



ACCLAIM & LEE ASSOCIATES, INC.

No. 5, Alley 30, Lane 405, Fute 1st Rd., Hsichih Dist., New Taipei City, Taiwan 221

Tel:886-2-2694-3278, 2694-3479

Fax:886-2-2694-4627

E-mail: acclaim@ms15.hinet.net

Website: www.acclaim.com.tw



Furniture And Building Hardware (Locks Included)

FONG PERNG INTERNATIONAL CORP.	31
KINGBOLT METAL CO., LTD.	32
ABA UFO INTERNATIONAL CORP.	33
HOU LIH CO., LTD.	34
JIH SHENG SPRING CO., LTD.	35
LEADING TOOLS INDUSTRIAL CO., LTD.	36
TAIWAN MAGNETIC CORP. LTD.	37

FONG PERNG INTERNATIONAL CORP.

Snaps, Hooks, Rings, Dees, Shackles, Pet Collars/Leads/Harnesses, Hores Halters/Blankets/Racing Saddles, Girths, Pads,

Fong Perng International Corp. is one of the leading Manufacturer/exporter for chain/rope accessories and harness / pet products, including all kinds of snap, hook, buckle, ring, clip, pet lead/collar/harness, horse halter/girth/rug. Having more than 15 years experience in the hardware market, our business is built on customer service supreme quality with reasonable price and punctual delivery. We also accept customer's design or samples. We do our designing by computer (cad-cam) made by die casting aluminum/zinc alloy and plastic. Manufacturer/exporter for chain/rope accessories and harness hardware, including all kinds of snap, hook, buckle, ring, clip, made by stamped steel, zinc die casting, malleable iron and solid brass sand casting, drop forging, stainless steel.

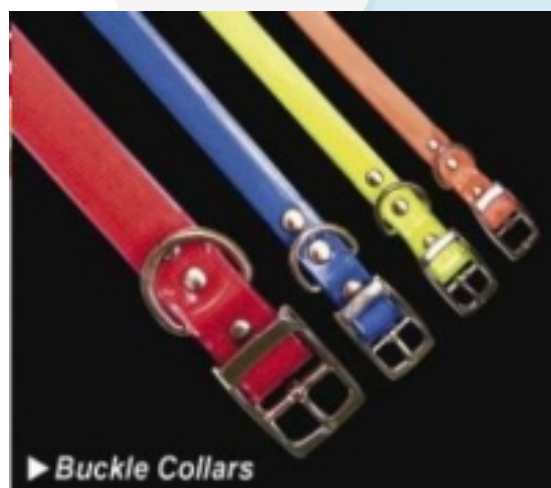

► Buckle Collars

PU Coated Nylon Webbing Pet Products



Stable Rug

FONG PERNG INTERNATIONAL CORP.

7th Fl.-3, 139 Chienkuo N. Rd., Sec. 2, Taipei, Taiwan 104

Tel:886-2-2516-8980

Fax:886-2-2516-3668, 2516-8985

E-mail: fongpong@ms24.hinet.net

Website: www.fongperng.com

KINGBOLT METAL CO., LTD.

Aluminum Carabiner (Snap Hook), Anode Finish, Key Ring, Wire Hook: Loop Peg Hook, Display Hook, Cup Hook, Screw Eye, Brass Product: Clip,

• Welcome you to visit our web pages. •
 We are established 1975. Banker: BANK OF TAIWAN, MINCHUAN BRANCH (TAIPEI) Swift: TWTW TPA 046 Tel Number: 886-2-25530121 FAX Number: 886-2-25514253 Telex Number: 27244 BOTMINCH Account Number: 38767 Kingbolt Metal Co., Ltd. Stamping, wire forming, welded conjunction are our speciality. Hardware & Fasteners are also available. We could deliver you the finest quality product. Call-up associated manufacturers are closed cooperation with us to make various parts for our main prod .

..



EDM



TUBE HINGE 4"



TUBE HINGE 4"



TUBE HINGE 4"



KINGBOLT METAL CO., LTD.

3F-5, No. 26, Sec. 2, Min Chuan E. Rd., Taipei, Taiwan 104

Tel:886-2-2563-9019

Fax:886-2-2561-8903

E-mail: okingbolt@xuite.net

Website: www.kingboltco.com.tw

ABA UFO INTERNATIONAL CORP.

**Lock, Cable Locks, Door Lock Set,
Cam Lock, Vending Machine,
Cylinder Locks, Padlocks,
Computer Locks, Laptop Security**

ABA UFO INTERNATIONAL CORP., was established in 1983 mainly produces and export variety locks. The company is founded on the principals of designing innovative, high quality, products at competitive prices. The quality policy is efficiency improvement, cost reduction, quality assurance, customer satisfaction. Lock exports 40% of its products to the USA, 20% to the Europe and 20% to the Asia. Our main products included Cam Lock, Switch Lock, Lock Cylinder, Security devices, Steering Wheel Lock, Hardware, enclosure, OEM, ODM, Injection Parts, Zinc Die-casting Parts, Pressing Parts, Metal Injection Mould Parts, Latching Parts, Precise Casting Parts.

ABA UFO INTERNATIONAL CORP.

P.O. Box 13-222, Hsinchuang Dist., New Taipei City, Taiwan
242

Tel: 886-2-2906-8181

Fax: 886-2-2906-1942

E-mail: 161@abalocks.com

Website: www.cens.com/abalocks



High security Pagoda Switch Locks



High security Pagoda Cam Locks



Multi-application Security cable Lock

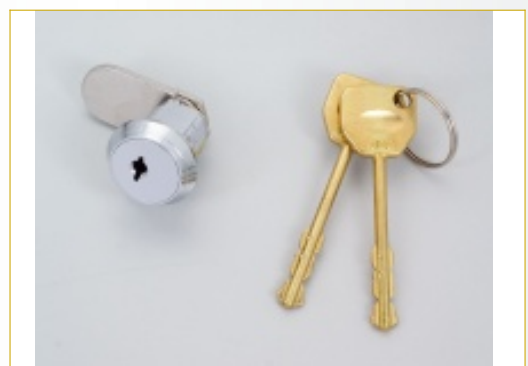

High Security Flat Key Pin Tumbler

HOU LIH CO., LTD.

Handles, Curtain Rod, Curtain Hooks, Curtain Accessories, Aluminum Oval, Also Available Steel, Round Tubing for Closet, Curtain Rods, Cast Iron

A 22-plus-year veteran in designing, making and selling metallic door, window and cabinet parts and accessories, Hou Lih mainly offers curtain hardware as tiebacks, curtain rods, rod supports, pins, rings, cabinet pulls and knobs, as well as electroplated and veneered iron and aluminum tubing/piping in various sizes and types. As a leading manufacturer, we are your best partner and OEM/ODM contractor, for we provide the best products, volume, along with competitive prices. Talk to us to see how we manage to fully meet customer needs to win their trust.



Ø 1 1/4"

STEEL ROD



Ø 1 5/16"

STEEL ROD



Ø 1 1/16"

STEEL ROD



Ø 1"

STEEL ROD

HOU LIH CO., LTD.

No. 9, Lane 262, Changnan Rd., Sec. 2, Changhua, Taiwan 500

Tel:886-4-737-2399, 738-9958

Fax:886-4-7387872

E-mail: sales@houlih.com.tw

Website: www.houlih.com.tw

JIH SHENG SPRING CO., LTD.

Springs, Custom Springs, Retaining Springs & Irregularly-Shaped Springs, Springs For Molds/Dies, Household Items

Established in 1997, Jih Sheng Spring Co., Ltd. has over 10 years of experience in making springs for electronics, electrical machinery, pneumatic/electric tools, automobiles, precision optical instruments, lighting products, hydraulic equipment, hardware (including locks), etc. Backed by advanced technology and innovative facilities, we now have two factories covering 86,400sq.ft. in total: one each focusing on precision spring manufacture and stamping hardware on straight-axle pneumatic presses. Well-equipped factories enable us to offer versatile processing services and prompt technical support. Using precision inspection instruments to ensure top quality, we became ISO 9001:2000 certified in January 2009.



JIH SHENG SPRING CO., LTD.

No. 117, Fuxing Lane, Homing Village, Hsiushui Township, Changhua County, Taiwan 504

Tel:886-4-769-6507

Fax:886-4-768-3303, 768-8422

E-mail: n45.n47@msa.hinet.net

Website: www.js-spring.com.tw



Staff

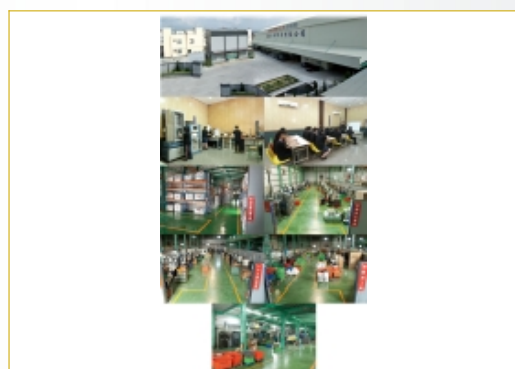

Spring Plant Facilities



Stamped Hardware Factory

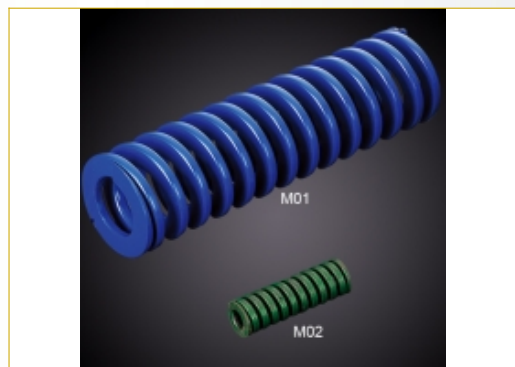

Springs For Molds/Dies

LEADING TOOLS INDUSTRIAL CO., LTD.

Putty Knives, Painting Tools, Masonry Tools, Grinding Materials Tools, Brick Tools, Notched Trowels, Finishing Trowel

Founded in 1982, Leading Tools Industrial Co. has specialized in the development and production of high-quality artisan tools, including finishing trowels, notched trowels, pointing and gauging trowels, masonry tools, brick and pointing tools, concrete tools, building tools, and flooring trowel. The company employs some 35 skilled workers at a factory in central Taiwan. The factory is installed with state-of-the-art machines to turn out over 10,000 pieces of high-end trowels per day. Most of the company's products are exported to Europe, Australia, Africa and the United States. With streamlined facilities and efficient operation, Leading Tools has been certified to meet ISO 9002 standards in 2001. In addition to manufacturing products in massive volume, the company also fabricates tailor-made products to meet special orders. To maintain its stren ...

LEADING TOOLS INDUSTRIAL CO., LTD.

No. 16, 32th Rd., Taichung Industrial Park, Taichung 407

Tel:886-4-2359-2999

Fax:886-4-2359-2989

E-mail: rick@leadingtool.com.tw

Website: www.leadingtool.com.tw



Pointing Brick Trowels-Masonry Tools

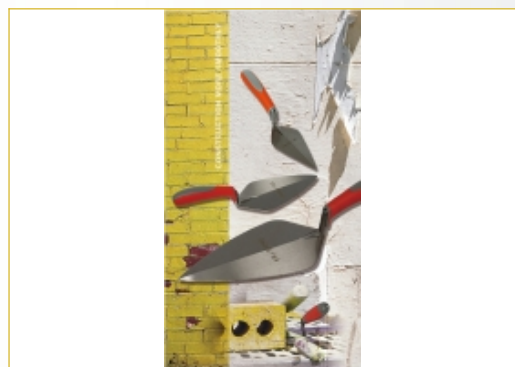

Pointing Brick Trowels, Cement Tools, Concrete Trowels



Plastering Trowels



Plastering Trowel/ Masonry Tools

TAIWAN MAGNETIC CORP. LTD.

Permanent Magnets, Magnetic Separators, Magnetic Products

Taiwan magnetic Corp., Ltd. established in 1980, has been a leading manufacturer and exporter of specialized magnetic products for over 30 years. We are highly recognized by our customers both locally and worldwide for our quality products and prompt service. We have a technical collaboration platform, manufacturing and distributing innovative and fine magnetic and magnetic related products with a wide range of applications, such as, permanent magnets for electronic products, ironware, motors, stationery and various kinds of sensors. Magnetic separators for all kinds of production lines, like ceramic, electric, mining, plastic, chemical, rubber, food, pharmaceutical, environmental, dyeing, metallurgical and recycling...etc. We also

TAIWAN MAGNETIC CORP. LTD.

4th Fl., No. 7, Lane 166, Chungyang Rd., Nankang Dist., Taipei, Taiwan
11573

Tel:886-2-2782-8123

Fax:886-2-2785-2393

E-mail: sales@allmagnet.com

Website: www.cens.com/allmagnet



Permanent Magnet



Magnetic Separator



Permanent Magnetic Lifter



Pot Magnetic



Screws & Bolts

NAN SHUN SPRING CO., LTD.

39

DEFA INTERNATIONAL INC.

40

NAN SHUN SPRING CO., LTD.

Precision Spring, Iron Wire Products, Electronic parts, Spring, Furniture Hardware, Hardware, Electronic and Computer Products

Established in 1987, our company is specialized in precision spring with research and design. We keep the development of our products to suit our customers' special demands and constantly research new products to fulfill markets. Our services and products have won worldwide customers' trusts, and we believe it will be your best choice! Main Products : Our company produces finest quality products which included springs/ wire forming, flats, clips, clothes hangers, hooks, rings, clamps, metal hardware parts, CNC processing products, spring leafs/ sheets, stainless steel hardware, pins, wire form bending shapes and etc. we also accepting order to produce all types of parts according to customers , sample or drawing (auto cad or pro/e 3D files). Machine Processing Equipments: Cutter Machine / Sawing Machine Grinder Machine Precision Milling M ...



NAN SHUN SPRING CO., LTD.

No. 6, Alley 63, Lane 446, Changmei Rd., Sec. 2, Tiehshan Borough, Homei Town, Changhua County, Taiwan 50848

Tel:886-4-735-9685

Fax:886-4-735-1091

E-mail: nanshun@nanshun.com.tw

Website: www.nanshun.com.tw

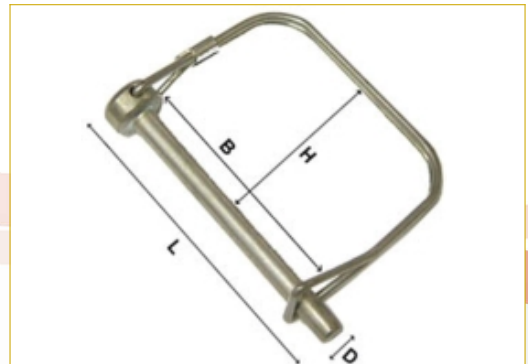

COUPLER LOCK PIN TYPE-2



Toothed Spring Pins / Powder Casing Spring Pins



Safety Pin Rings / Linch Pins / Lynch Pins



Shaft Lock Pin / Tube Clip / Linch Pin / Lynch Pin

DEFA INTERNATIONAL INC.

CNC Lathe Processing, Precision Metal Parts, Mechanical Hardware Parts, OEM Architectural Hardware, CNC Machined Parts

Defa International, Inc is a professional supplier of precision metal parts, can provide all kinds of OEM parts for manufacturing and processing markets. Our facilities are Japan CITIZEN CNC lathe machines, swiss type CNC Lathe machines , CNC precision milling machines and other advanced equipments. We can fast & sophisticate to produce of many kinds of metal parts in materials such as aluminum, iron, stainless steel, copper and special materials. Our product range cover all kinds of pipe fittings, architectural hardware, auto parts, machinery parts, bicycle parts, kitchen and bathroom hardware, medical equipment parts, industrial hardware, valve parts, food machinery parts, hardware tools ... and so on. DEFA can provide customers with the best service, providing tailored support to meet the needs of customer orders. We have a dedicated ...



DEFA INTERNATIONAL INC.

1F., No. 6-1, Zhongli Ln., Dali Rd., Dali Dist., Taichung City, Taiwan 41259

Tel:886-4-2407-6816

Fax:886-4-2407-6815

E-mail: info@defatools.com

Website: www.cens.com/defa



Hardware Parts



Hardware Parts Processing



Hardware Parts 1/4•CNC Lathing 1/4•CN Machined Parts



Hardware Parts Processing 1/4•CNC Lathing 1/4•CNC Machined Parts



Japanese



Russian



Spanish



Portuguese



German



Arabic



Chinese



French



Persian



Vietnamese



Burmese



Thai

See more by other language



CENS Global Pass, the Newest Sourcing Tool

e-Age

Product Sourcing for Global Buyers

9 languages for global accessibility



Source in your own language
Less work but more productivity

CENS.com

buyerservice@udngroup.com.tw