

## 型號

產品型號	燈數	流明	色溫	瓦數	光角	重量
J07-3WS5-D160WW	5 LEDs	415lm	3000K	12W	40°	0.8kg
J07-5WS5-D160WW	5 LEDs	482lm	3000K	20W	40°	0.8kg
J07-5WS7-D160WW	7 LEDs	526lm	5500K	32W	40°	0.8kg
J07-6WS7-D160CW	7 LEDs	634lm	5500K	40W	40°	0.8kg

瓦數: 12W~40W  
 照射角度: 40°  
 電壓: 110V~230V  
 色溫範圍: 3000~5500K  
 顏色: 暖白/冷白  
 角度調整: 旋轉360°/30°

Wattage: 12W ~ 40W  
 Irradiation angle: 40°  
 Voltage: 110V ~ 230V  
 Color temperature range: 3000 ~ 5500K  
 Color: Warm white / Cool white  
 Angle adjusting: 360° rotatable / 30° tilttable

## 安裝方式

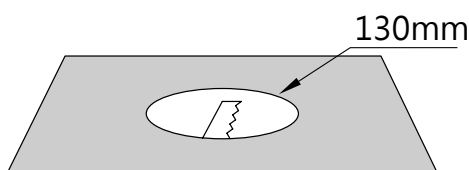

1. 根據產品規範尺寸在天花板切割一圓孔

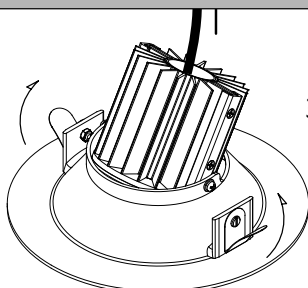
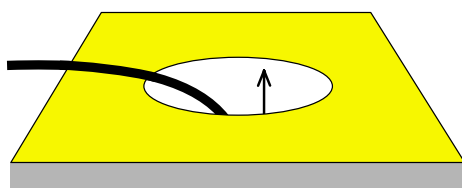

3. 將兩片彈性holder往內壓住,使燈具能穿入孔內再放開確認燈具已固定

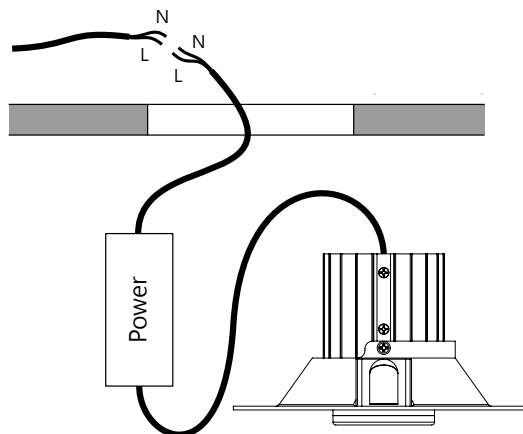

2. 連接Power端與110V~230V供電端(若有含控制則另外連接控制訊號端)

**J07嵌燈**系列可搭配燈光控制系統,有別於傳統燈具無法靈活變換燈光色溫/亮度顏色及效果變化,LED燈具能夠照明運用上更加豐富,可搭配以下各種控制系統使燈光設計師能針對不同場景需求更好的搭配運用效果

### 控制系統簡易說明: (DMX System)

下圖5個區域各有不同的照明配光需求,利用DMX系統分別對5個區域內LED發出控制訊號,經過解碼器定址不同的燈具,可針對每個區域做調整達到所需空間照明之質感

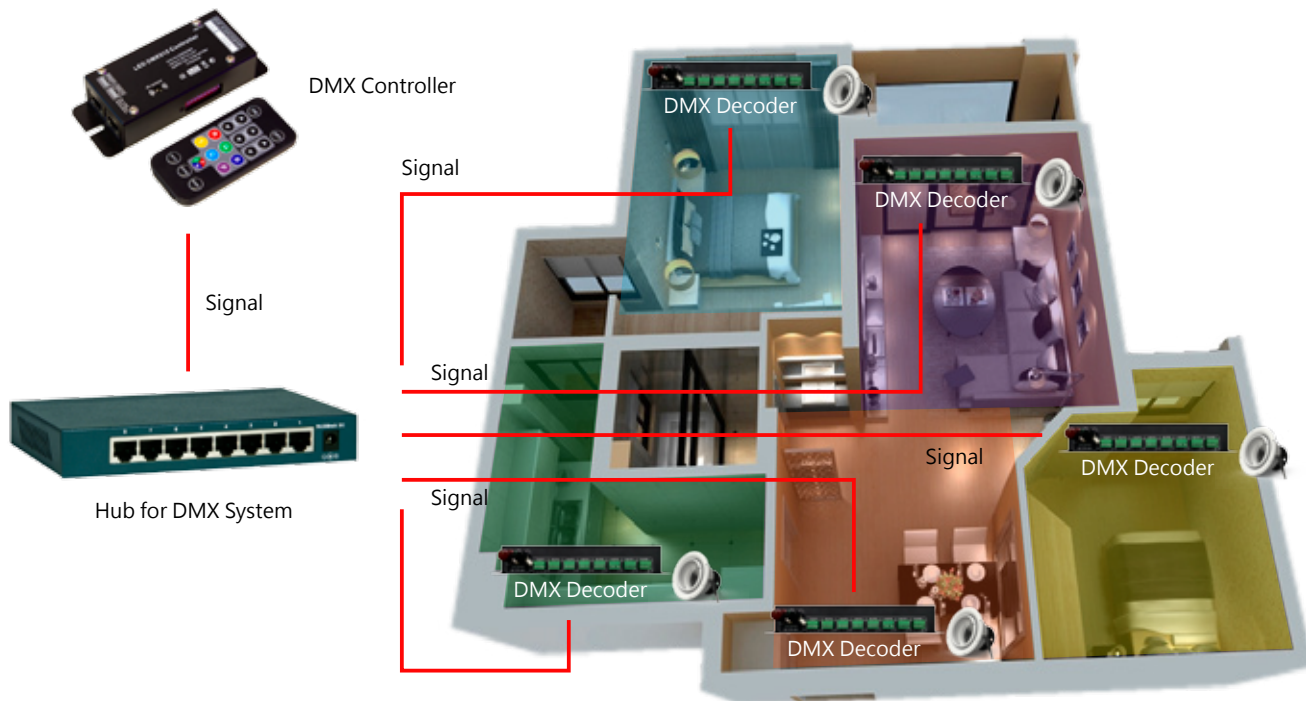

### 控制系統示意: (DALI System)

下圖5個區域各有不同的照明配光需求,利用DALI系統分別對5個區域內LED發出控制訊號,經過控制系統預先定址不同的燈具,可針對每個區域做調整達到所需空間照明之質感



DALI

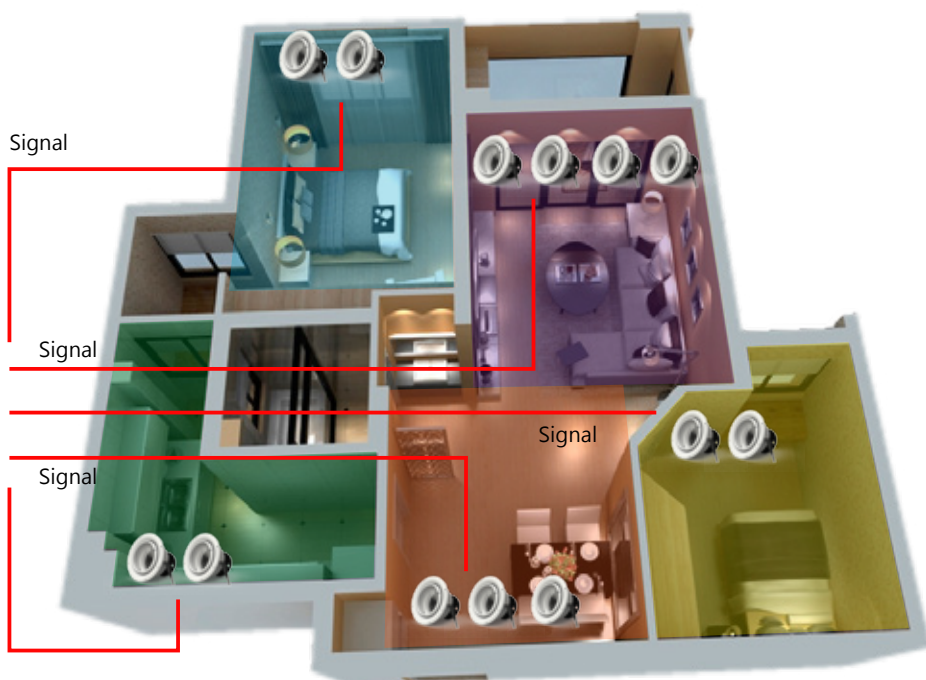
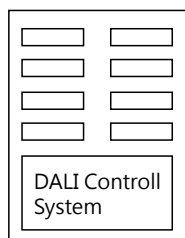

**J07嵌燈**系列可搭配WIFI遙控燈光的變化控制,無線的功能使燈具控制更靈活更方便,只要搭配相關的控制器或者採用手機/平板上的APP功能就可以控制區域內的燈具照明,結合科技與智能是照明最佳的選擇,高達1600萬色的調整隨時豐富您的生活



WIFI Controller



Lighting Controller  
Android / iPhone APP

請用滑鼠點擊

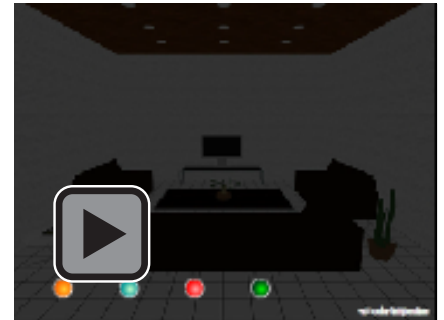

Indoor of Summer



B / W

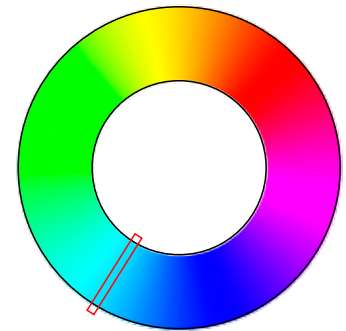

RGB

夏天室內較悶熱,經由控制器調整室內照明採用較冷色溫來搭配整體降溫感



B / W

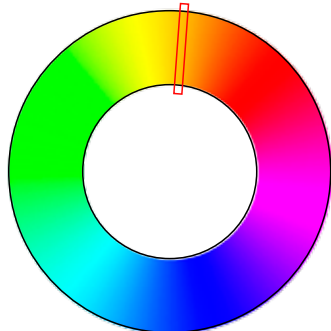

RGB

冬天室內溫度較低,此時用控制器調整室內照明暖色溫使室內感覺較溫暖

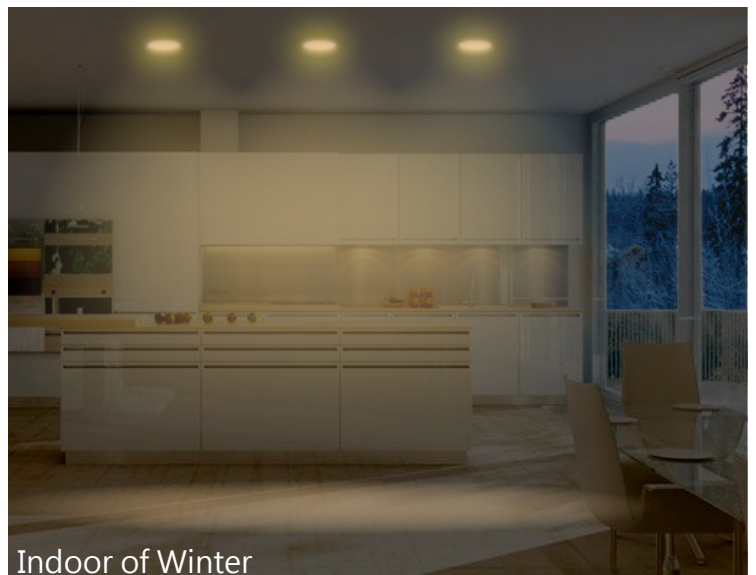

Indoor of Winter

J07嵌燈系列可額外搭配不同光學片來達到改變光形及防眩的功能

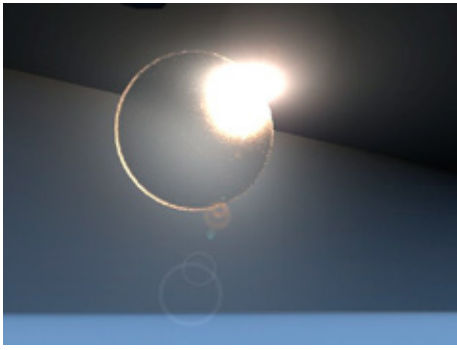

遮光防眩

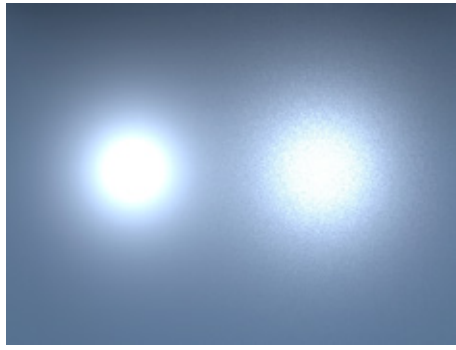

集中光形

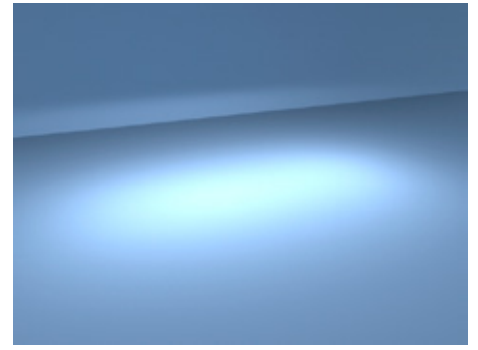

拉長光形

可視需要區域內集中或者範圍照明的效果  
針對照明標的物不同光形需求來自由調整:

